



Medallion Fence

10651 KEELE STREET
 MAPLE, ONTARIO L6A 3Y9
 (T) 905-832-2922 || 1-800-794-1564 || (F) 905-832-1564
 info@medallionfence.com || www.medallionfence.com

Medallion Fence

STYLE:
WINDSOR-A-AL

SERIES:
HAWKSTON™

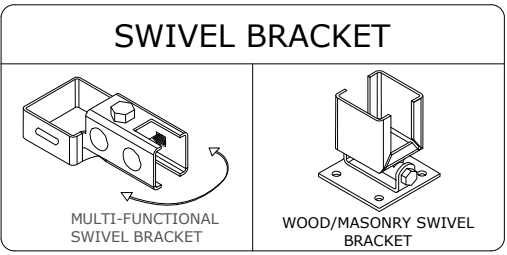
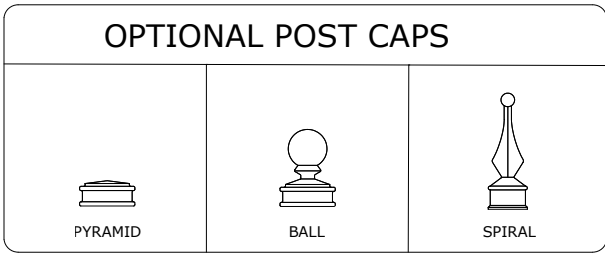
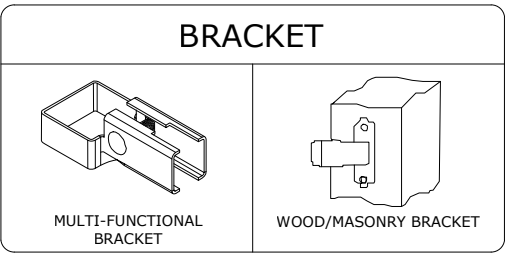
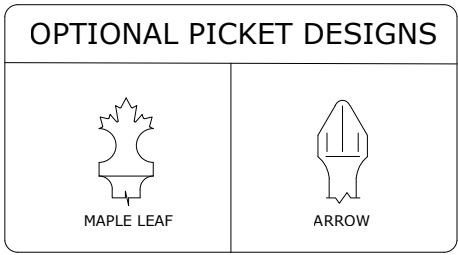
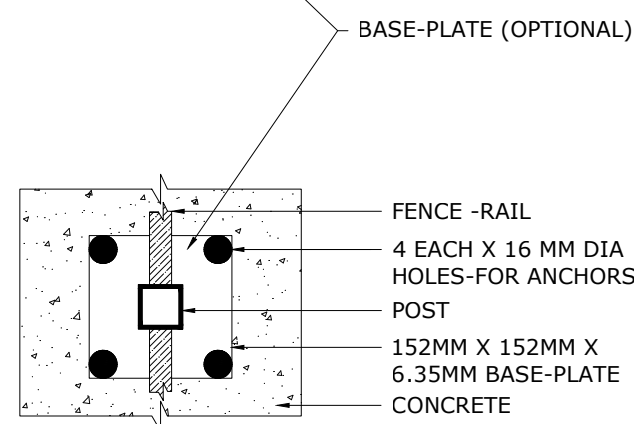
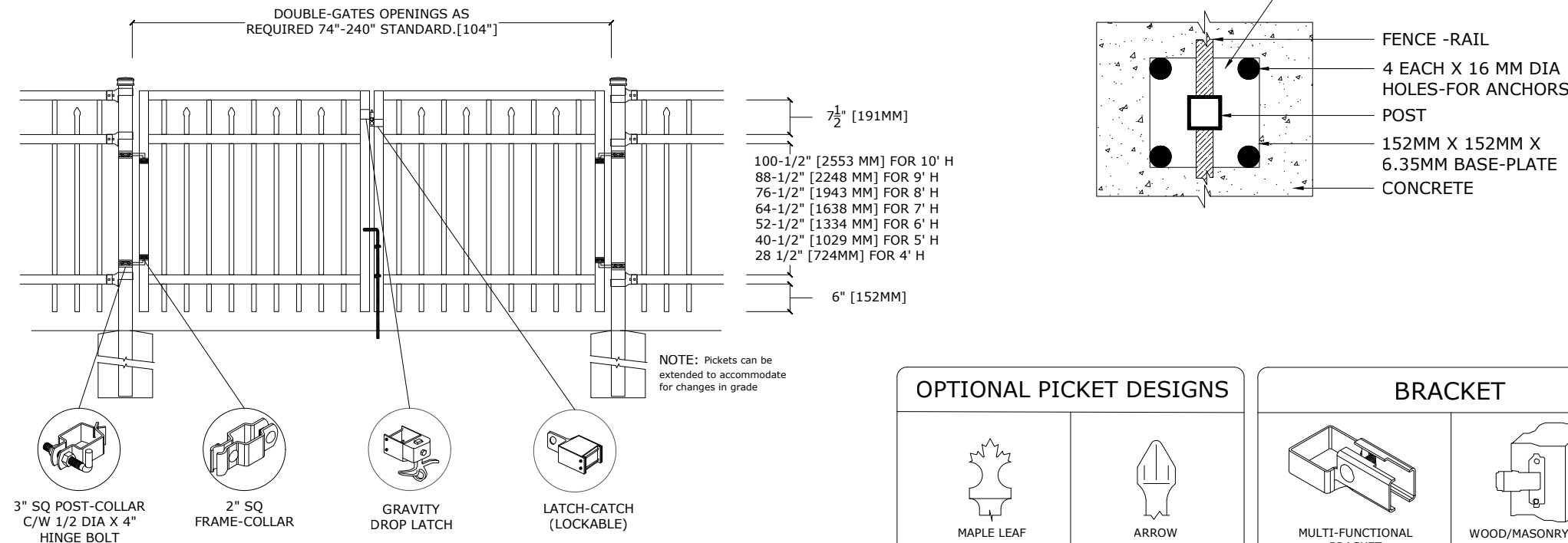
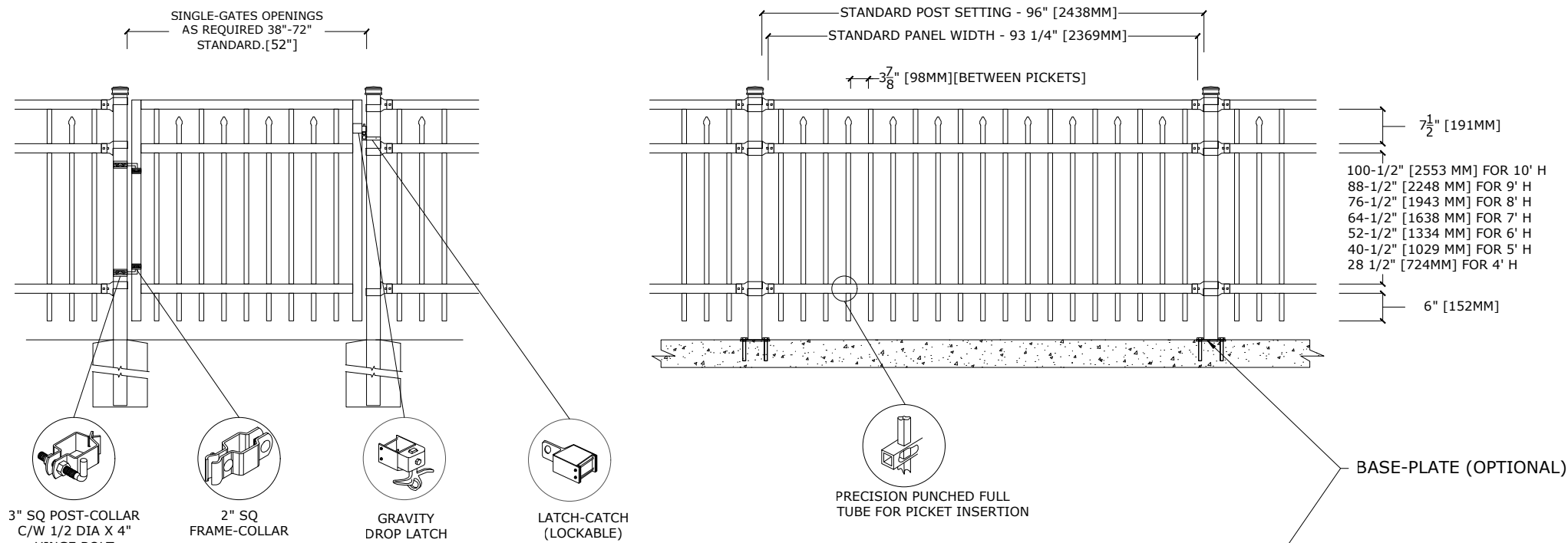

SPECIFICATIONS

- TUBE COMPOSITION - POSTS , RAILS & PICKETS**
- HIGH-STRENGTH EXTRUDED ALUMINUM ALLOY (6061-T4 & 6061-T6 TEMPERS)
 - ULTIMATE TENSILE STRENGTH: ≈ 290 MPA (T4), ≈ 339 MPA (T6)
 - YIELD STRENGTH: ≈ 210 MPA (T4), ≈ 317 MPA (T6)
 - ELONGATION: ≈ 8%-16% (T6), UP TO ~16%+ (T4) DEPENDING ON THICKNESS

MATERIAL DIMENSIONS

PICKET	1" x 1" (25mm x 25mm) .080 Wall
RAILS	2" x 2" [50mmx50mm] .125 Wall
POSTS REGULAR or BASE-PLATED	3" x 3" [76mm x 76mm] .188 Wall
OPTIONAL POST REGULAR or BASE-PLATED	Larger profiles available - contact Medallion Fence
UPRIGHTS	2" x 2" [50mmx50mm] .188 Wall

WELDS	Aluminum Mig Weld
FITTINGS	12 Gauge Stamp Forged Finish as below
FITTING FASTENERS	JS1000 Plated Finish as below
OPTIONAL FASTENER	Tamper Proof Nuts

FINISH

GRADE	Super Durable Polyester Powder Coat
OPTIONAL PRIMER	Zinc Rich Epoxy Powder Coat
OPTIONAL PRIMER (2)	E-Coat
STANDARD COLOUR	SEMI-GLOSS - BLACK
OTHER COLOURS	Green, Brown, White, Antique Silver
CUSTOM COLOURS	Per Specifications

STANDARD HEIGHTS	4' 1219MM	5' 1524MM	6' 1892MM	7' 2134MM	8' 2438MM	9' 2743MM	10' 3048MM
	Custom heights are available (upon request)						

STANDARD GATES	Passage, Double Entry, Cantilever
----------------	-----------------------------------

STANDARD POST SETTING & PANEL WIDTH

FOR FENCE HEIGHTS	PANEL WIDTH	POST SPACING [OPENING]
Up to 6' [1829mm]	93 1/4" [2369MM]	96" [2438 MM]
Over 6' [1829mm]	93 1/4" [2369MM]	96" [2438 MM]

MATERIAL SPECIFICATIONS:
 ALU-TUFF™
 BY MEDALLION FENCE

