

Medallion Fence

10651 KEELE STREET
MAPLE, ONTARIO L6A 3Y9
(T) 905-832-2922 || 1-800-794-1564 || (F) 905-832-1564
info@medallionfence.com || www.medallionfence.com

Medallion Fence

STYLE:
ARISTOCRAT-DR-DDEP

SERIES:
FAIRMONT™

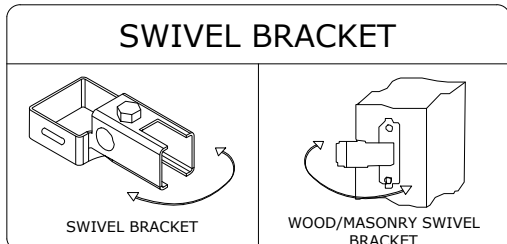
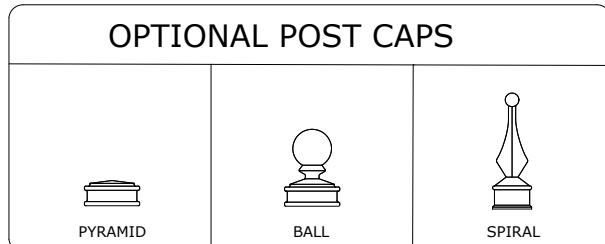
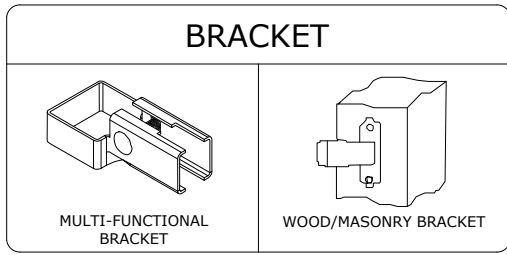
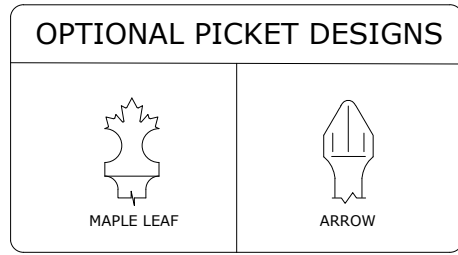
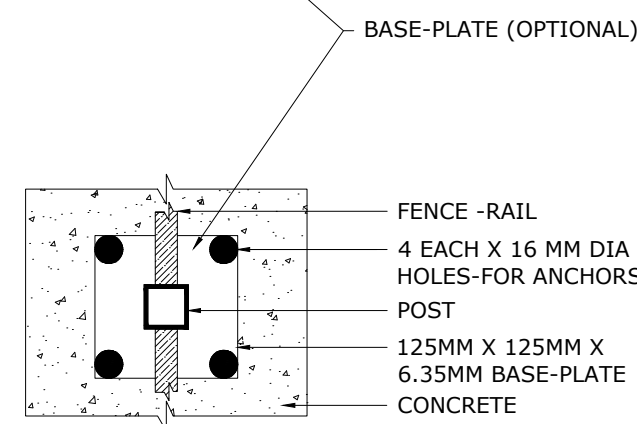
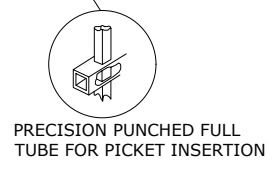
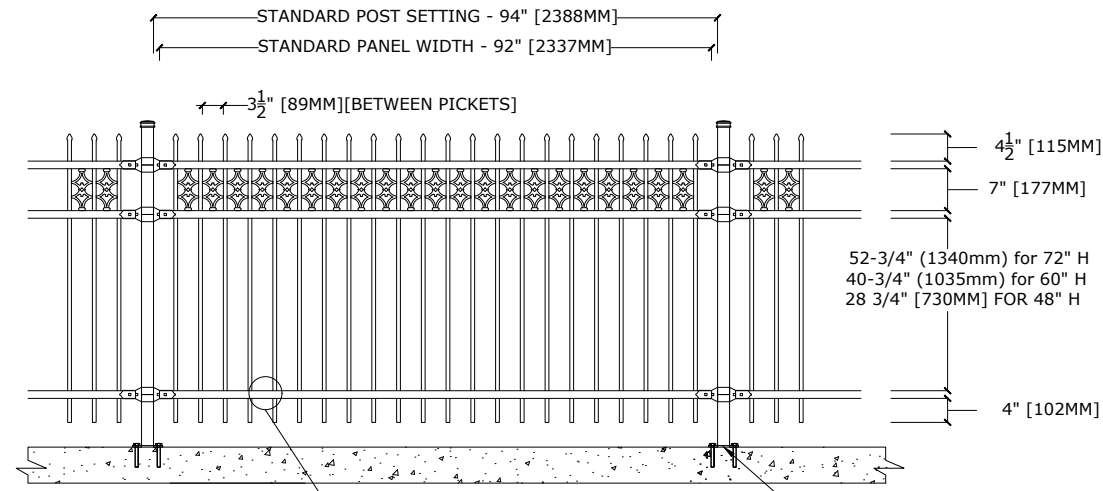
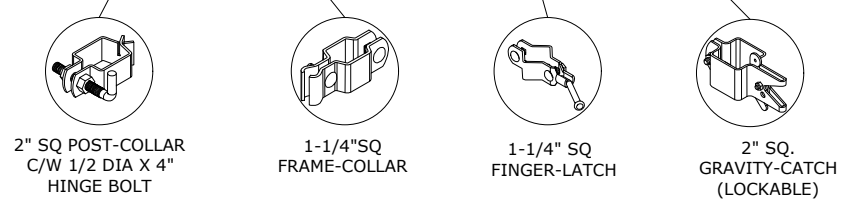
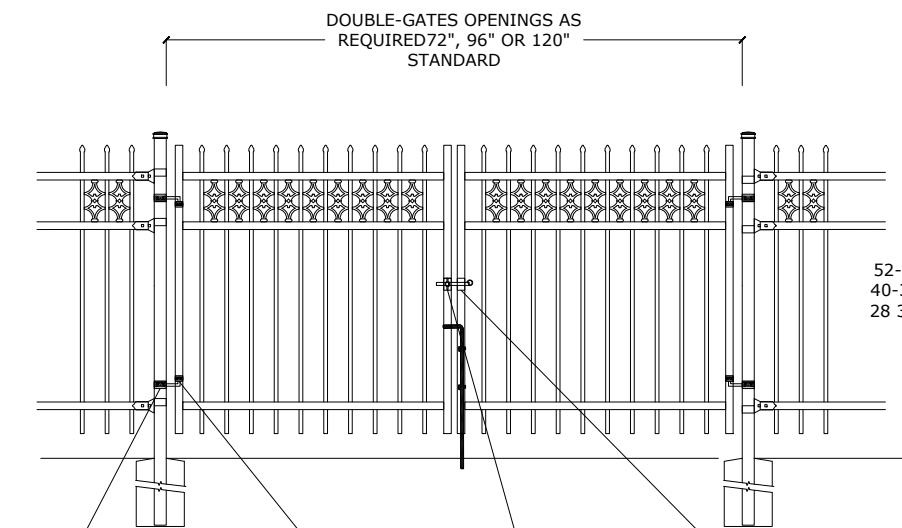
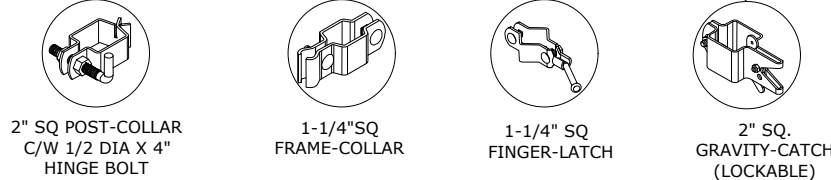
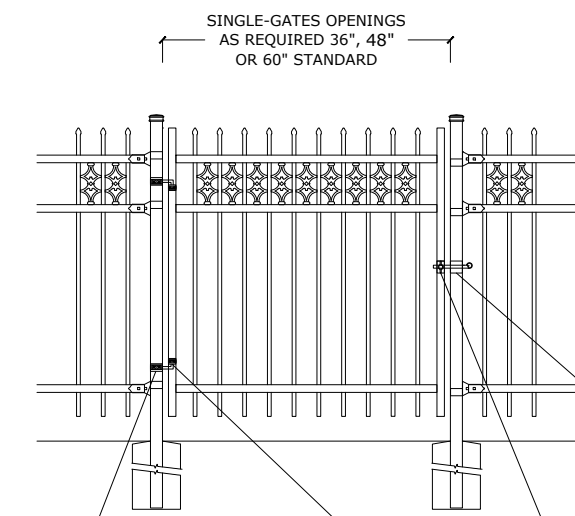

MATERIAL SPECIFICATIONS:
ARMOUR-SHIELD™
BY MEDALLION FENCE



SPECIFICATIONS

TUBE COMPOSITION - POSTS , RAILS & PICKETS

- MINIMUM YIELD STRENGTH: 45 KSI (310 MPA)
- MINIMUM TENSILE STRENGTH: 55 KSI (380 MPA)
- ASTM A787 (TUBE)
- TUBE MANUFACTURED FROM PRE-COATED ALUMINUM-ZINC COATED STEEL WITH COATING DESIGNATION AZ50 CONFORMING TO ASTM A792/A792M

MATERIAL DIMENSIONS

PICKET	5/8" x 5/8" (16mm x 16mm) 18 GA
RAILS	1-1/4" x 1-1/4" (32mm x 32mm) 16 GA
POSTS REGULAR or BASE-PLATED	2" x 2" (51mm x 51mm) 16 GA or 14 GA
OPTIONAL POST REGULAR or BASE-PLATED	2-1/2" x 2-1/2" (64mmx64mm) 14 GA
UPRIGHTS	1-1/4" x 1-1/4" (32mm x 32mm) 16 GA or 14 GA

WELDS	Stainless Steel Mig Weld
FITTINGS	14 Gauge Stamp Forged Finish as below
FITTING FASTENERS	JS1000 Plated Finish as below
OPTIONAL FASTENER	Tamper Proof Nuts

FINISH

GRADE	Super Durable Polyester Powder Coat
OPTIONAL PRIMER	Zinc Rich Epoxy Powder Coat
OPTIONAL PRIMER (2)	E-Coat
STANDARD COLOUR	SEMI-GLOSS - BLACK
OTHER COLOURS	Green, Brown, White, Antique Silver
CUSTOM COLOURS	Per Specifications

STANDARD HEIGHTS	NA	NA	48' 1219mm	60' 1524mm	72' 1892mm
	Custom heights are available (upon request)				

STANDARD GATES	Passage, Double Entry, Cantilever
----------------	-----------------------------------

STANDARD POST SETTING & PANEL WIDTH

FOR FENCE HEIGHTS	PANEL WIDTH	POST SPACING [OPENING]
Up to 6' [1829mm]	92" [2337MM]	94" [2388 MM]
Over 6' [1829mm]	NA	