



# Medallion Fence

10651 KEELE STREET  
 MAPLE, ONTARIO L6A 3Y9  
 (T) 905-832-2922 || 1-800-794-1564 || (F) 905-832-1564  
 info@medallionfence.com || www.medallionfence.com

Medallion Fence

**STYLE:**  
**STANTON**

**SERIES:**  
**WELLINGTON™**

SINGLE-GATES OPENINGS  
 AS REQUIRED 36", 46"  
 OR 60" STANDARD

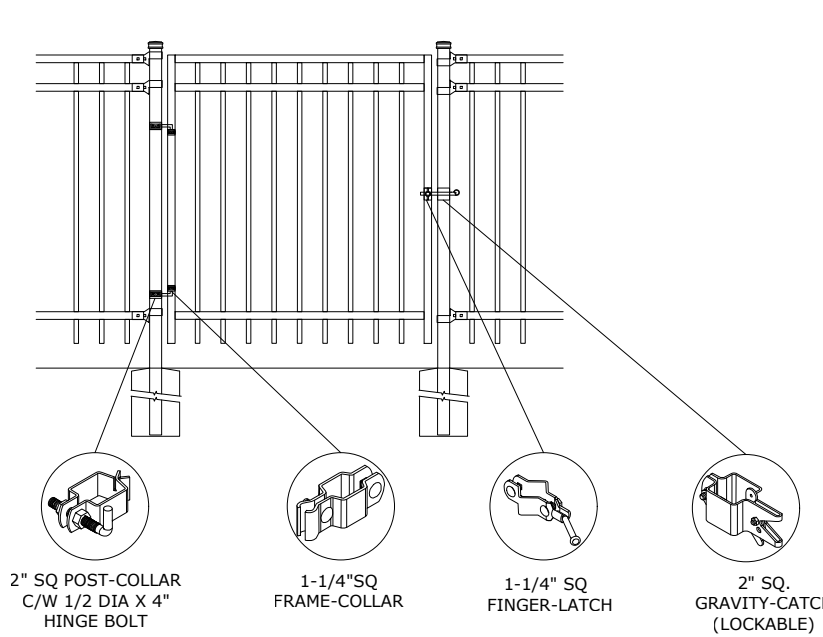

STANDARD POST SETTING - 92 1/2" [2350MM]  
 STANDARD PANEL WIDTH - 90 1/2" [2299MM]

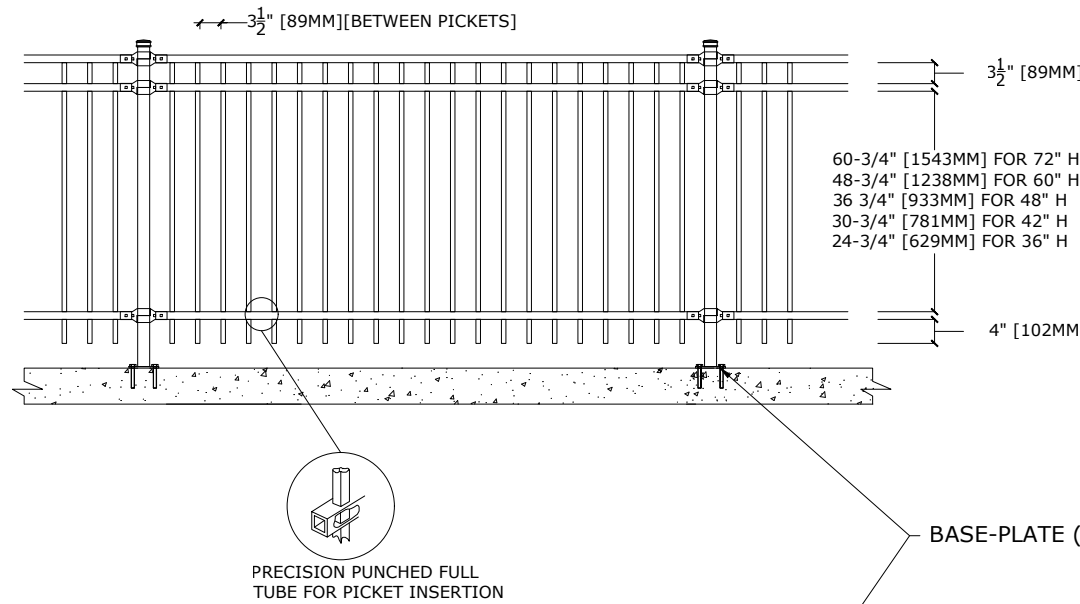

BASE-PLATE (OPTIONAL)

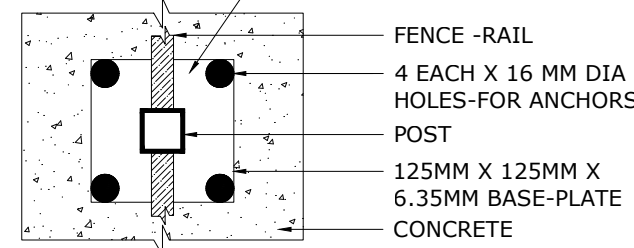

DOUBLE-GATES OPENINGS AS  
 REQUIRED 72", 92" OR 120"  
 STANDARD

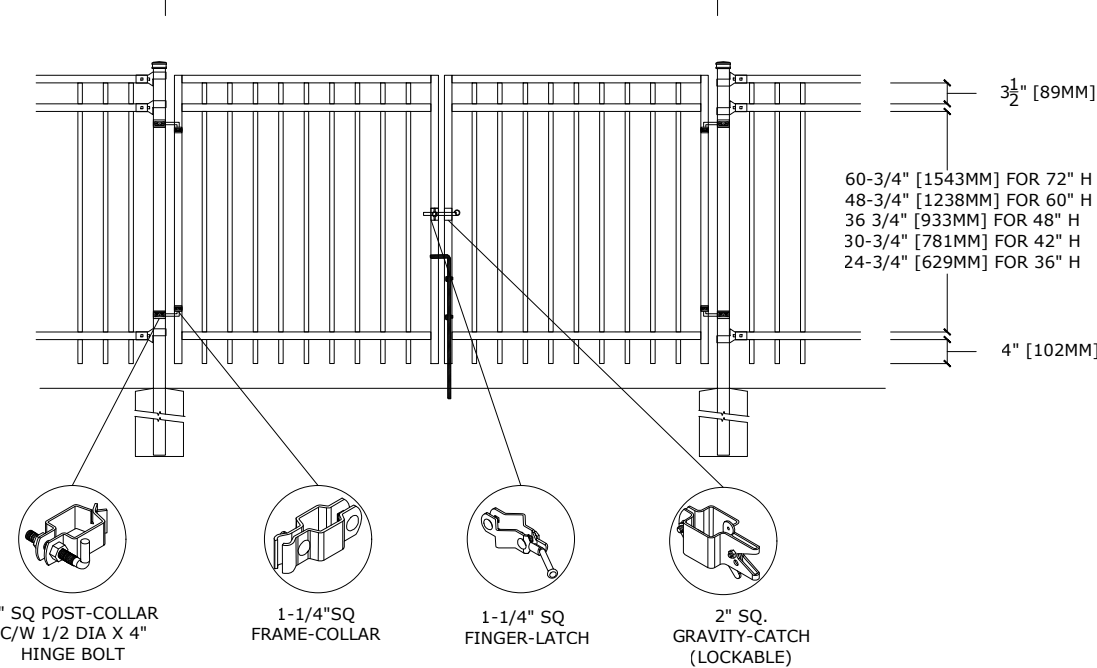

### BRACKET

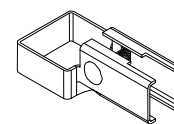

MULTI-FUNCTIONAL BRACKET

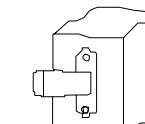

WOOD/MASONRY BRACKET

### SWIVEL BRACKET

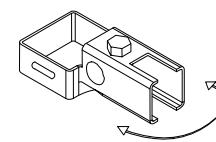

SWIVEL BRACKET

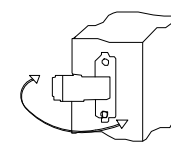

WOOD/MASONRY SWIVEL BRACKET

### MATERIAL SPECIFICATIONS:

ARMOUR-SHIELD™  
 BY MEDALLION FENCE

PROTECTED BY

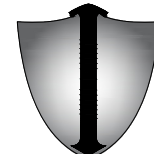

ARMOUR-SHIELD™

### OPTIONAL POST CAPS



PYRAMID



BALL



SPIRAL

### SPECIFICATIONS

#### TUBE COMPOSITION - POSTS , RAILS & PICKETS

- MINIMUM YIELD STRENGTH: 45 KSI (310 MPA)
- MINIMUM TENSILE STRENGTH: 55 KSI (380 MPA)
- ASTM A787 (TUBE)
- TUBE MANUFACTURED FROM PRE-COATED ALUMINUM-ZINC COATED STEEL WITH COATING DESIGNATION AZ50 CONFORMING TO ASTM A792/A792M

### MATERIAL DIMENSIONS

PICKET	3/4" x 3/4" (19mm x 19mm) 18 GA
RAILS	1-1/4" x 1-1/4" (32mm x 32mm) 16 GA
POSTS REGULAR or BASE-PLATED	2" x 2" (51mm x 51mm) 16 GA or 14 GA
OPTIONAL POST REGULAR or BASE-PLATED	2-1/2" x 2-1/2" (64mmx64mm) 14 GA
UPRIGHTS	1-1/4" x 1-1/4" (32mm x 32mm) 16 GA or 14 GA

<b>WELDS</b>	Stainless Steel Mig Weld
<b>FITTINGS</b>	14 Gauge Stamp Forged Finish as below
FITTING FASTENERS	JS1000 Plated Finish as below
OPTIONAL FASTENER	Tamper Proof Nuts

### FINISH

<b>GRADE</b>	Super Durable Polyester Powder Coat
OPTIONAL PRIMER	Zinc Rich Epoxy Powder Coat
OPTIONAL PRIMER (2)	E-Coat
STANDARD COLOUR	SEMI-GLOSS - BLACK
OTHER COLOURS	Green, Brown, White, Antique Silver
CUSTOM COLOURS	Per Specifications

<b>STANDARD HEIGHTS</b>	36" 914mm	42" 1067mm	48" 1219mm	60" 1524mm	72" 1892mm
	Custom heights are available (upon request)				

STANDARD GATES	Passage, Double Entry, Cantilever
----------------	-----------------------------------

### STANDARD POST SETTING & PANEL WIDTH

FOR FENCE HEIGHTS	PANEL WIDTH	POST SPACING [OPENING]
Up to 6' [1829mm]	94 1/2" [2400MM]	96 1/2" [2452 MM]
Over 6' [1829mm]	NA	